

1. ASSEMBLY OF GT-V

GT-V is mounted with the back piece on the wall. Circuit board with sensor is mounted in the front piece. The housing is adapted for mounting over appliances.

1:1

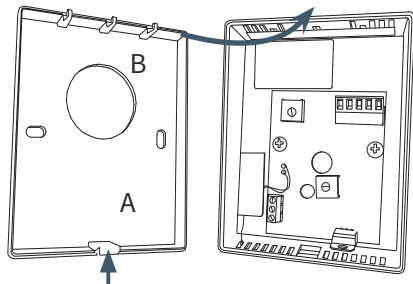

[1:1] The front piece is loosened via snap device [A] and then unhooked at the top edge [B].

1:2

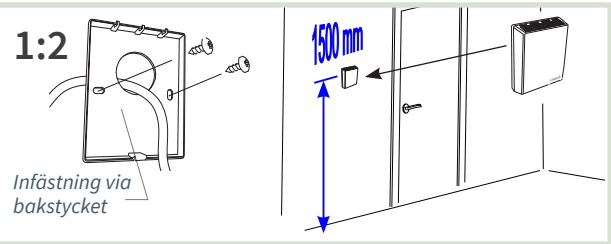

[1:2] Location: Avoid placement right next to a passage where air currents can cause misleading measured values.

1:3

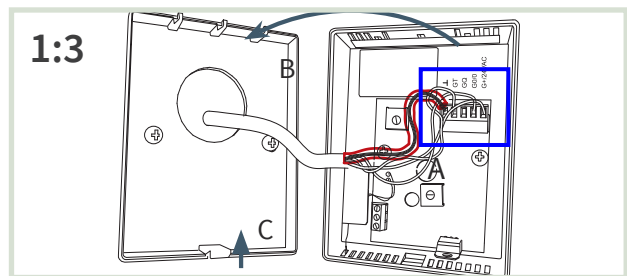

[1:3] [A] In connection with connection: Use bi-conductor hose to shield. Refit the front piece [B] and [C].

2. CONNECTION OF GT-V

Note: Connection mark with connection diagram is located on the inside of the cover for enclosures.

[2:1] Preparations

- = Note: Use bi-conductor hose to shield.
- = Conductor + shield connected according to the product connection diagram.
- = Vlect the appropriate socket in the enclosure for cable entry.

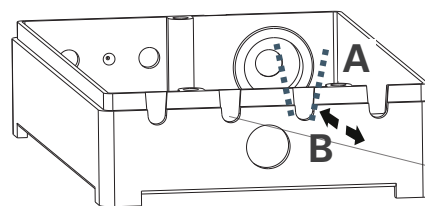

A: Cut x2 .....  
 B: Fold / break off. Adjust sockets with cutters.  
 Surface for outlet in enclosure.

[2:2] Make sockets in enclosures for cabling: LCX and RCX. Use cutting pliers to [A] open the appropriate socket in the enclosure and to [B] trim the socket.

3. CONNECTION: CONTROLLERS LCX / LCXB / RCX / RCXB

Wiring is anchored when the cover is screwed on after connection!

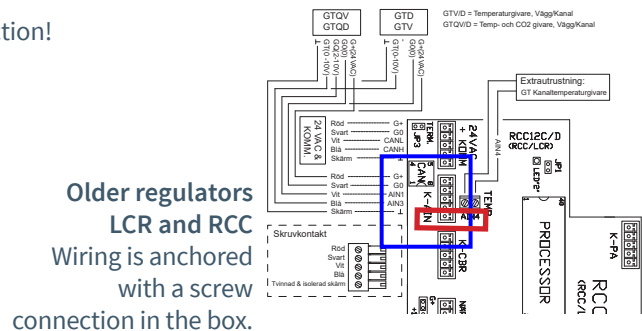
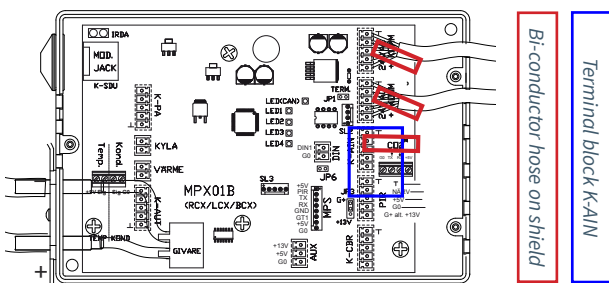

4. GT-V AND OTHER CONTROL UNITS FOR ROOM CLIMATE

Control units not mentioned above usually have other equipment for measuring room temperature.

SEE THE NEXT PAGE FOR COMMISSIONING INSTRUCTIONS!

**MANUAL SETTINGS**

**FOR MEASURED VALUES FROM GT-V**

- Necessary settings of AIN functions on the connected control unit with parameter settings are reported here.
  - LCX and RCX (Duct-mounted controllers for Lab and room climate)
  - LCR and RCC (Older equivalents of LCX and RCX)
- Mobile application LINDINSIDE is used for logging in to RCXb and LCXb. For guidance, see the commissioning instructions for each control unit.
- The DHP handset is used to log in to:
  - LCX och RCX (Wireless or Wired)
  - LCR och RCC (Wireless or Wired)
- Settings can also be made on all devices via the parent network. See the communication tool LINDINSPECT®.

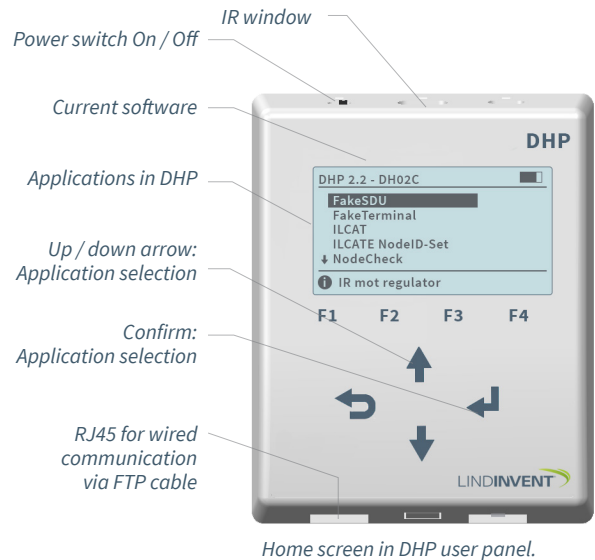
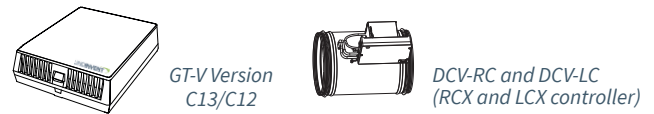

**1. SETTINGS AIN: LCX AND RCX**

Login on LCX and RCX:

- Wireless with DHP: Select application FakeSDU.
- Wired with DHP and FTP cable: Select application Serial SDU.
- Login to RCXb and LCXb: Only via LINDINSIDE.

After logging: Go to the menu item "Settings"	
In / Out signals	Function / Value
AIN3	
Feature (Note 1)	Room temperature
Param. 1	12
Param. 2	43

**LCX och RCX**

**Note 1** Selecting functions from a predefined list.  
 AIN: <Inaktiv>; <Spjäll>; <Rumstemp>; <Tilluftstemp>; <CO2-givare>...

**2. SETTINGS AIN LCR AND RCC**

- Login only wired via DHP with FTP and after program selection SDU.

After logging: Go to the menu item "Settings"	
In / Out signals	Function / Value
AIN3	
Feature (Note 1)	Room temperature
Param. 1	12
Param. 2	43

**LCXR och RCC**

**Note 1** Selecting functions from a predefined list.  
 AIN: <Inaktiv>; <Väggratt>; <Temp. rum>; <Temp.tilluft>; <CO2-givare>...

**3. OTHER CONTROL UNITS FOR ROOM CLIMATE**

Control units not mentioned above usually have other equipment for measuring room temperature.

SEE THE NEXT PAGE FOR INSTALLATION INSTRUCTIONS!